

ZONEN		ZONEN		ZONEN	
NO.	NO.	NO.	NO.	NO.	NO.
1	2	3	4	5	6
7	8	9	10	11	12
13	14	15	16	17	18
19	20	21	22	23	24
25	26	27	28	29	30
31	32	33	34	35	36
37	38	39	40	41	42
43	44	45	46	47	48
49	50	51	52	53	54
55	56	57	58	59	60
61	62	63	64	65	66
67	68	69	70	71	72
73	74	75	76	77	78
79	80	81	82	83	84
85	86	87	88	89	90
91	92	93	94	95	96
97	98	99	100		

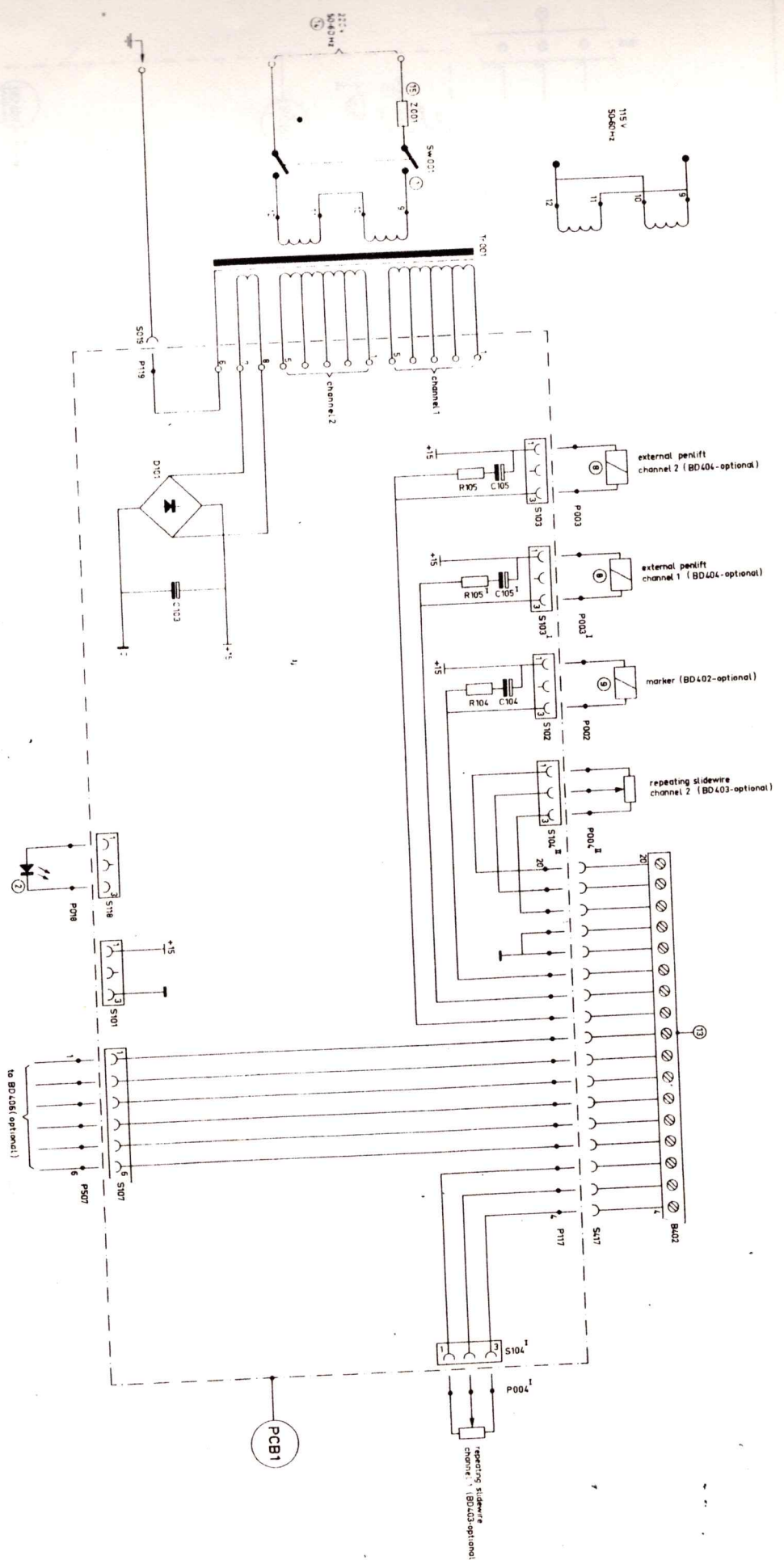

REV	DATE	BY	CHKD	DESCRIPTION
1				
2				
3				
4				
5				
6				
7				
8				
9				
10				

WEE & ZORN

ST. LOUIS, MO.

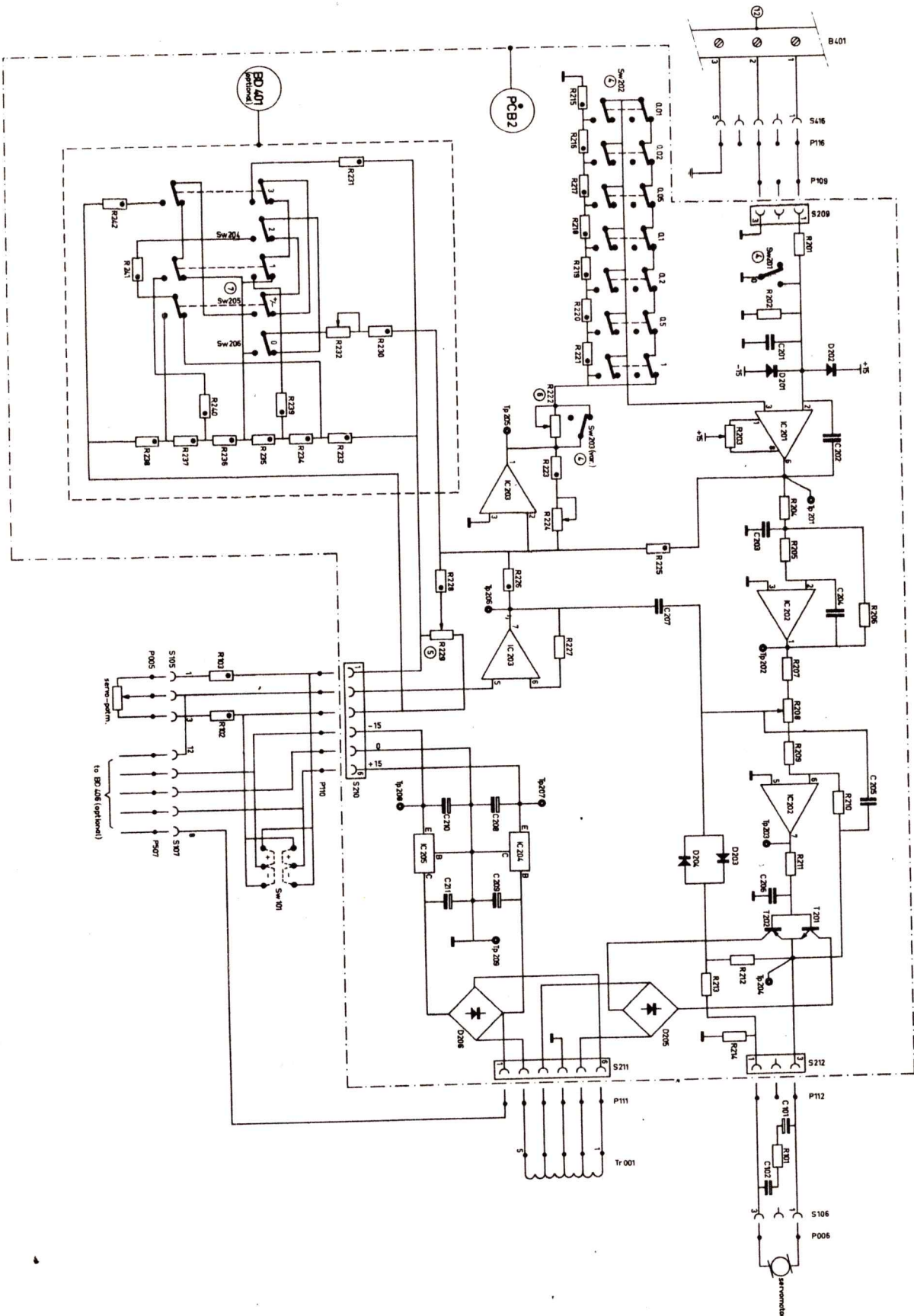

DESIGN & ZONE		DATE		REV	
1	DESIGN	1988	10	1	1
2	ZONE	1988	10	1	1
3	DESIGN	1988	10	1	1
4	ZONE	1988	10	1	1
5	DESIGN	1988	10	1	1
6	ZONE	1988	10	1	1
7	DESIGN	1988	10	1	1
8	ZONE	1988	10	1	1
9	DESIGN	1988	10	1	1
10	ZONE	1988	10	1	1

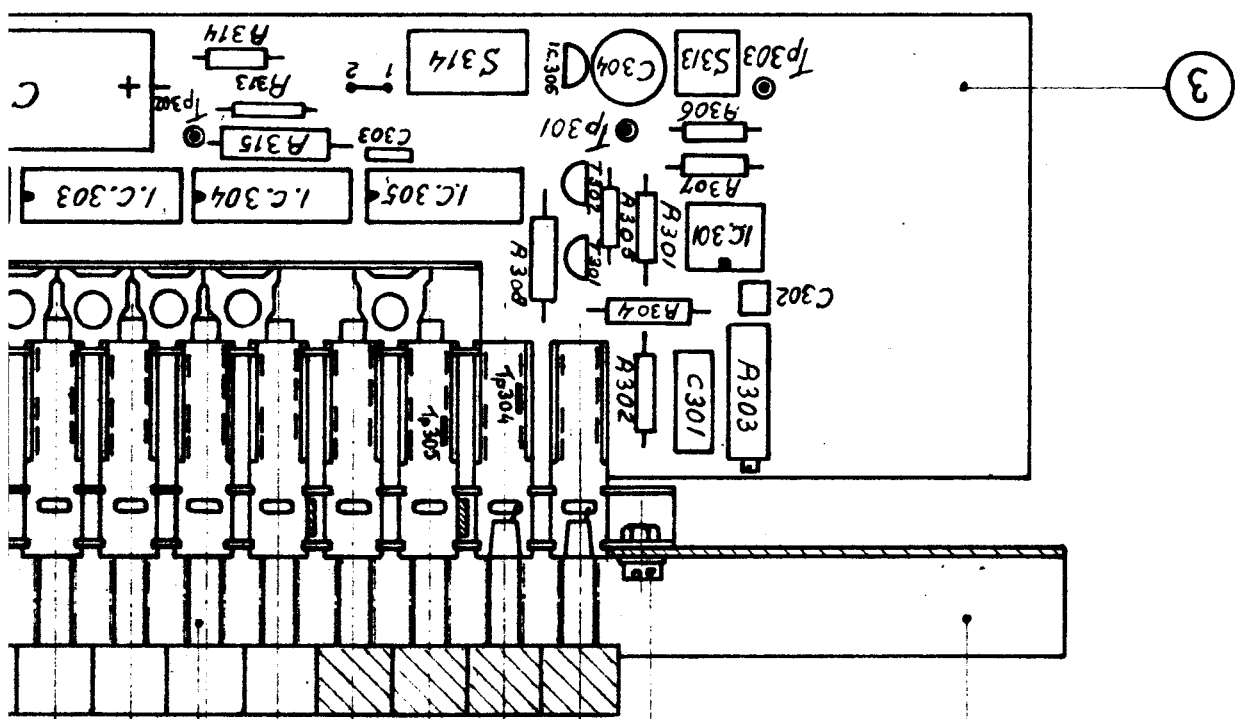

- 1313-901-2
- 1313-902-2
- 1313-911-2
- 1313-912-2
- 1313-915-2
- 1313-916-2
- 1313-921-2
- 1313-922-2

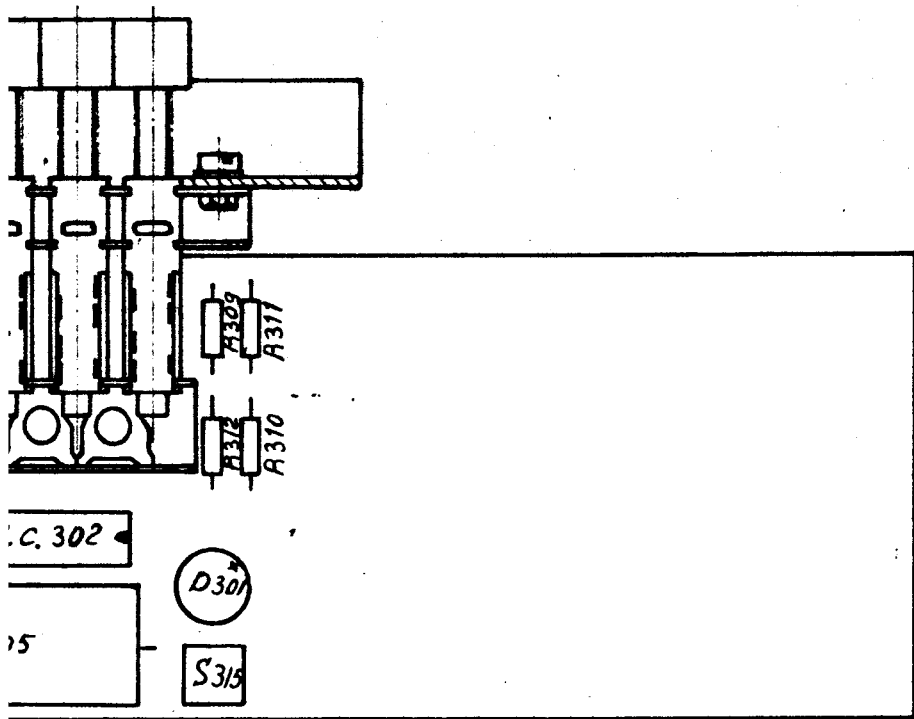

det.	tek. nr.	form.	aant.	codenummer	benaming		
					25 [±] = 25 ± 2	25 ⁰ = 25 ± 0.2	25 ⁰⁰ = 25 ± 0.02
					25 = 25 ± 1	25 ⁰ = 25 ± 0.1	25 ⁰⁰ = 25 ± 0.01
					25 = 25 ± 0.5	250 = 25 ± 0.05	2500 = 25 ± 0.005
					schaal 1:1	vervangt	dat. 31 mei '76
KIPP	Opst. print (papiertransport)				0313-504-3		1
	KIPP-DELFT-HOLLAND				get.		2
						opst	3

0313-488-2
0313-489-2

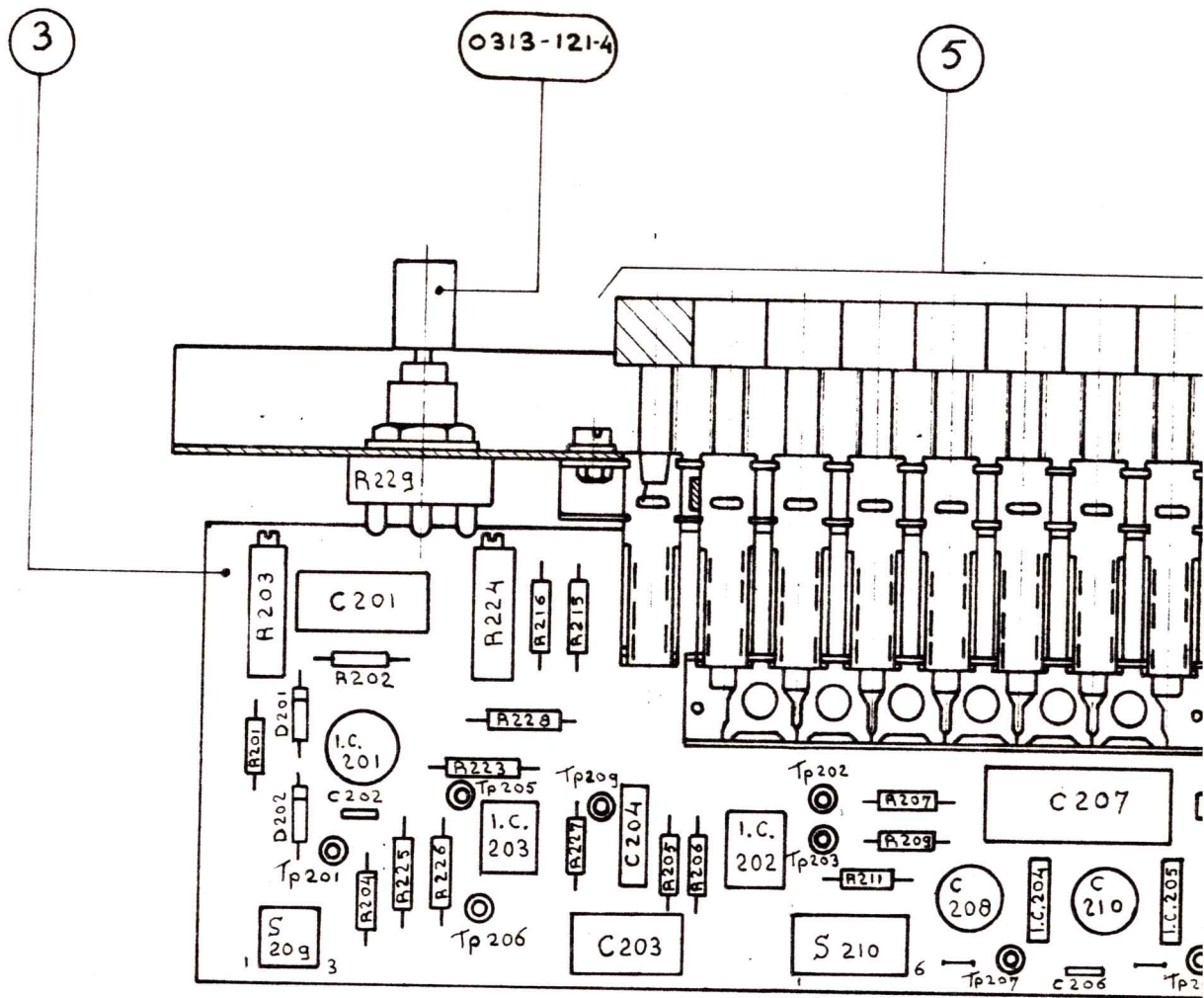

mc
be
op
⊕

10

0313-122-4

6

1

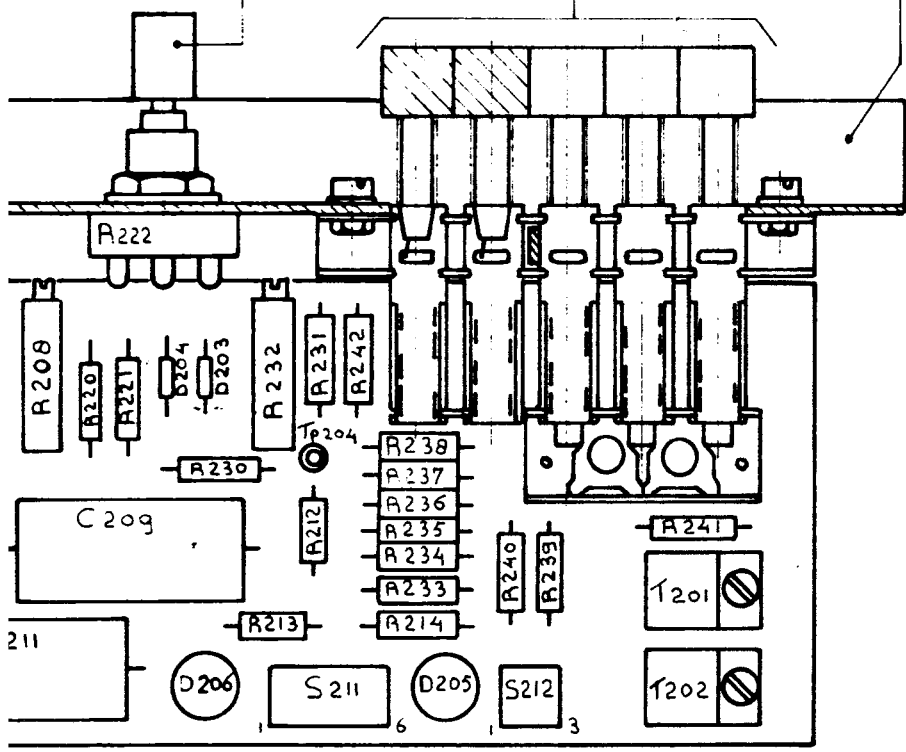

tek. nr.	form	aant	codenummer	benaming
				$25 = 25 \pm 2$ $25 = 25 \pm 1$ $25 = 25 \pm 0.5$
				$250 = 25 \pm 0.2$ $250 = 25 \pm 0.1$ $250 = 25 \pm 0.05$
				$2500 = 25 \pm 0.02$ $2500 = 25 \pm 0.01$ $2500 = 25 \pm 0.005$
				schaal 1 : 1 vervangt dat.
				print servo + nulp. and.
				0313-511-3
				KIPP - DELFT - HOLLAND
				get. <i>[Signature]</i>
				opst. A
				1 2 3

0313-498-2

0313-499-2

0313-121-4

5

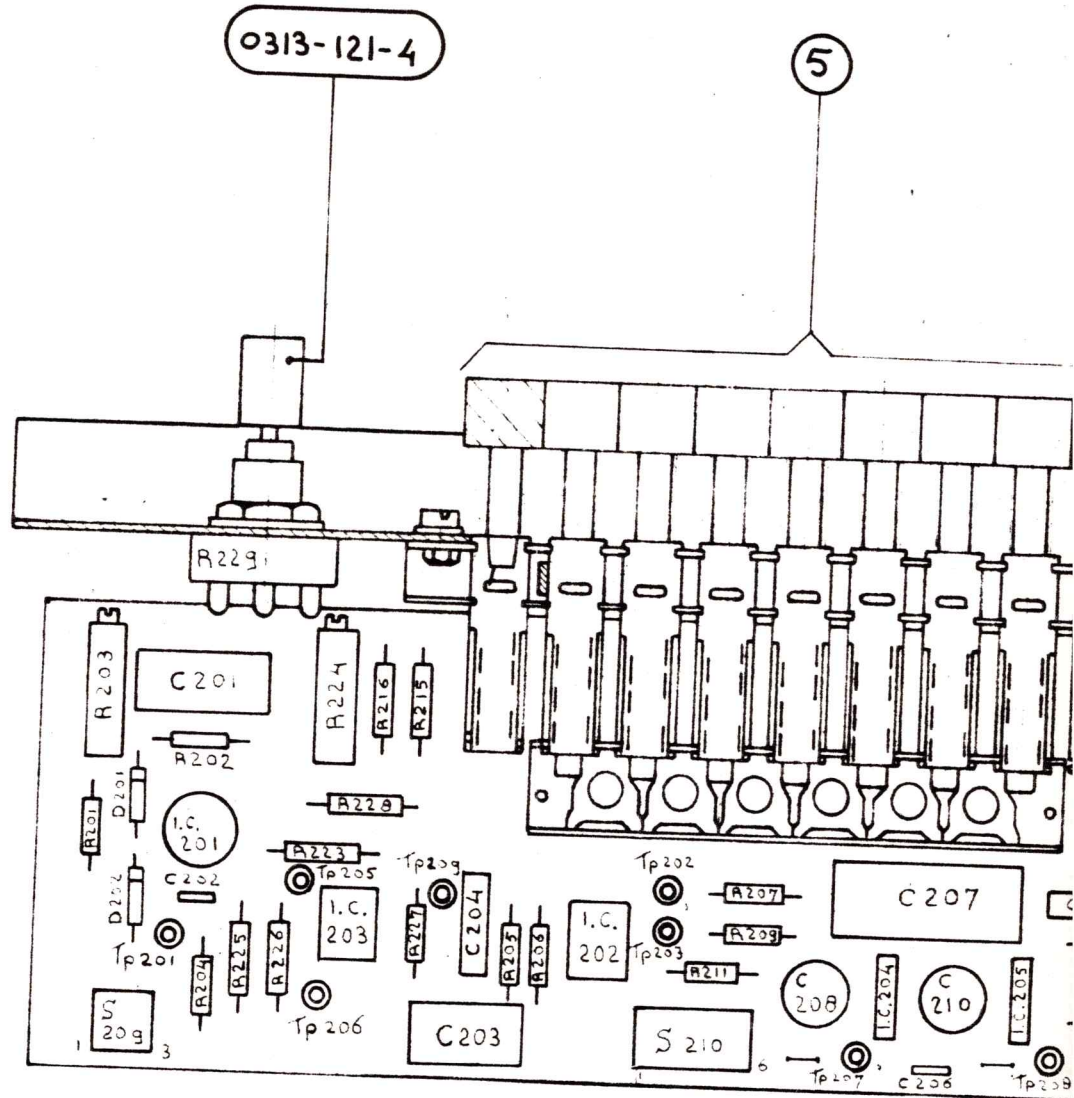

mat
bew
opw

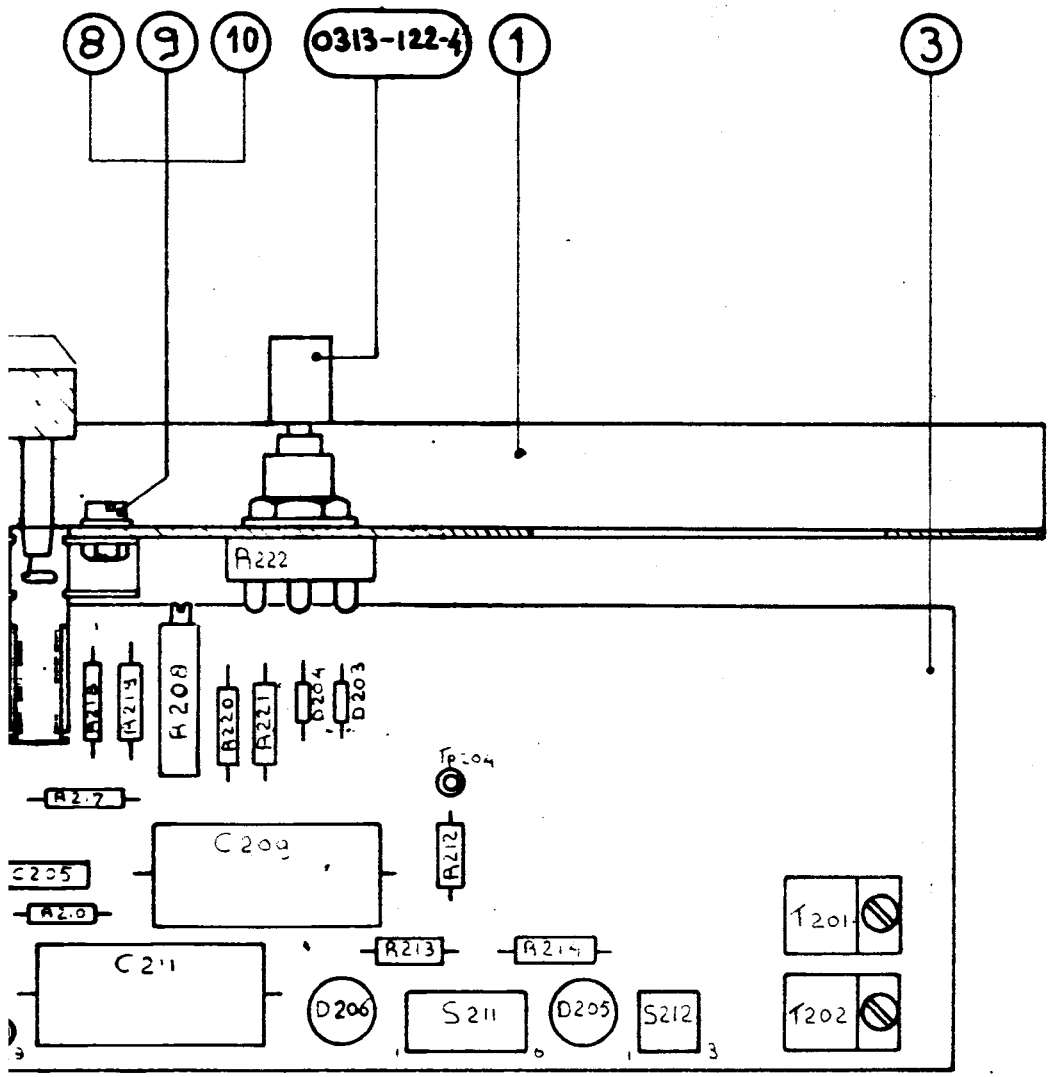

det	te	nr	form	aant	codenummer	benaming		
at						25 $\bar{5}$ = 25 ± 2	25 $\bar{0}$ = 25 ± 02	250 $\bar{0}$ = 25 ± 002
aw						25 $\bar{5}$ = 25 ± 1	25 $\bar{0}$ = 25 ± 01	2500 $\bar{0}$ = 25 ± 001
aw						25 = 25 ± 05	250 = 25 ± 005	2500 = 25 ± 0005
						schaal 1:1	vervangt	dat
KIPP						print 2 servo	0313-503-3	1
KIPP - DELFT - HOLLAND						get <i>P. H. H.</i>		2
						opst	A	3

0313-488-2
 0313-489-2
 0313-498-2
 0313-499-2

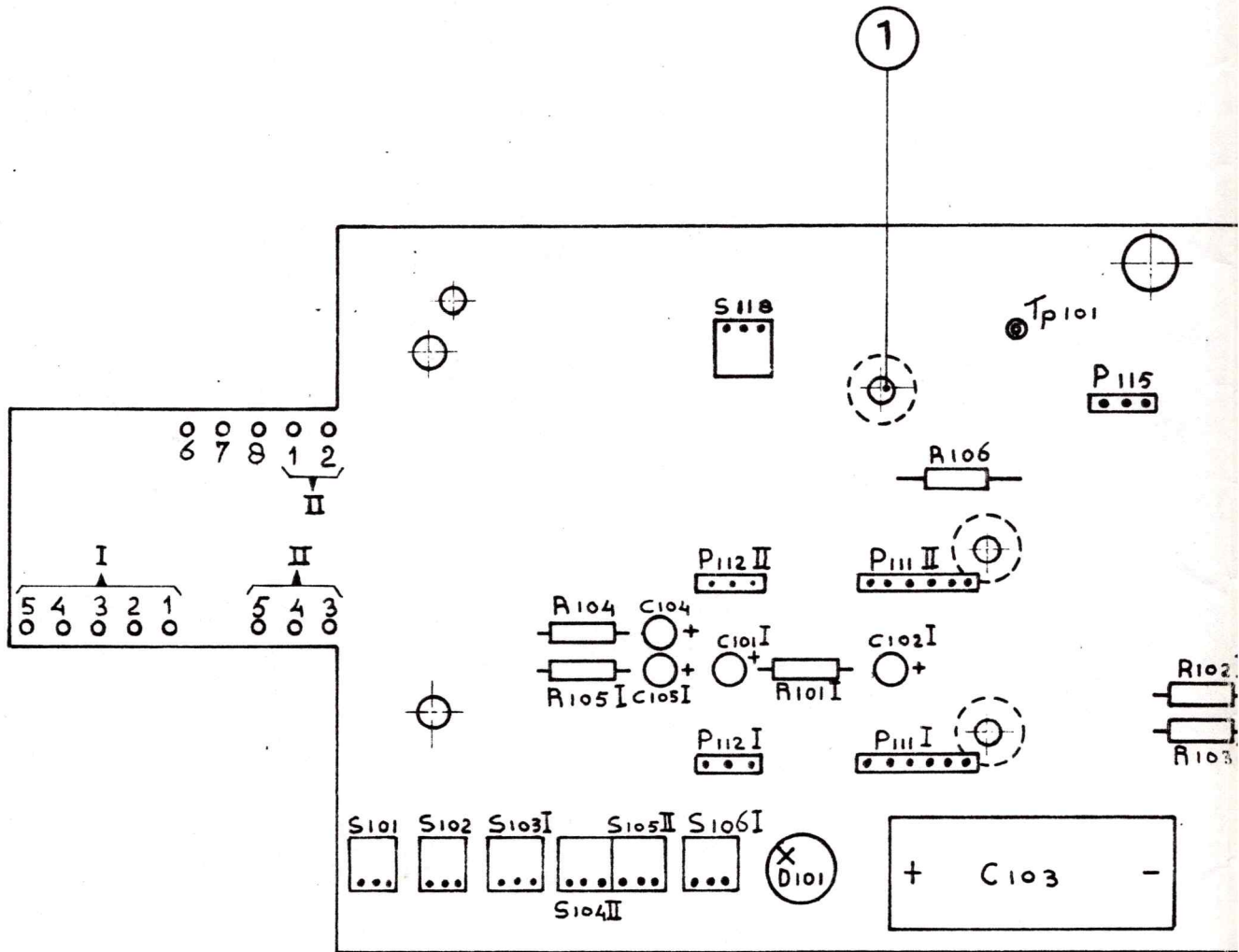

ma
 bev
 opv

2

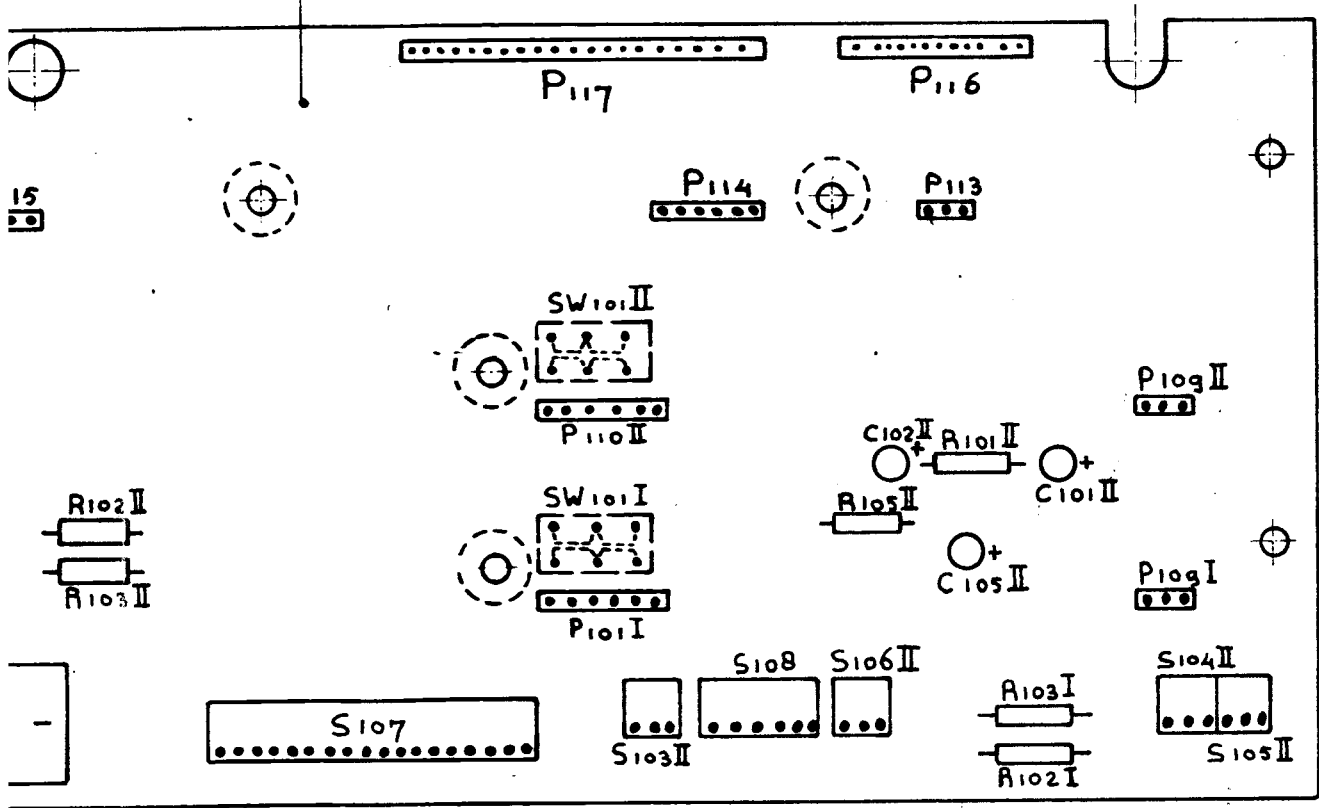

	det	tek nr.	form	aant	codenummer	benaming			
mat.						$25^{\sim} = 25 \pm 2$	$25\bar{0} = 25 \pm 0.2$	$25\bar{00} = 25 \pm 0.02$	
bew.						$25^{\sim} = 25 \pm 1$	$25\bar{0} = 25 \pm 0.1$	$25\bar{00} = 25 \pm 0.01$	
opw.						$25 = 25 \pm 0.5$	$25.0 = 25 \pm 0.05$	$25.00 = 25 \pm 0.005$	
						schaal 1:1	vervangt	dat. 31 mei '76	
	Opst. Bodemprint BD 40-41					0313-501-3			
	KIPP - DELFT - HOLLAND					get.	<i>M</i>	opst.	1
									2
								3	